

Product data sheet

Characteristics

XS4P12PA370

Inductive proximity sensors XS, inductive sensor XS4 M12, L52mm, PPS, Sn4mm, 12...48 VDC, cable 2 m



Product availability: Non-Stock - Not normally stocked in distribution facility

Price*: 84.48 USD



Main

Range of product	Telemecanique Inductive proximity sensors XS
Series name	General purpose
Sensor type	Inductive proximity sensor
Sensor name	XS4
Sensor design	Cylindrical M12
Size	52 mm
Body type	Fixed
Detector flush mounting acceptance	Non flush mountable
Material	Plastic
Type of output signal	Discrete
Wiring technique	3-wire
[Sn] nominal sensing distance	0.16 In (4 mm)
Discrete output function	1 NO
Output circuit type	DC
Discrete output type	PNP
Electrical connection	Cable
Cable length	6.56 Ft (2 m)
[Us] rated supply voltage	12...48 V DC with reverse polarity protection
Switching capacity in mA	<= 200 mA DC with overload and short-circuit protection
IP degree of protection	IP68 double insulation conforming to IEC 60529

Complementary

Thread type	M12 x 1
Detection face	Frontal
Front material	PPS
Enclosure material	PPS
Operating zone	0.00...0.13 In (0...3.2 mm)
Differential travel	1...15% of Sr

Cable composition	3 x 0.34 mm ²
Wire insulation material	PvR
Status LED	Output state: 1 LED (yellow)
Supply voltage limits	10...58 V DC
Switching frequency	<= 5000 Hz
Maximum voltage drop	<2 V (closed)
Current consumption	0...10 mA no-load
Maximum delay first up	10 Ms
Maximum delay response	0.1 Ms
Maximum delay recovery	0.1 Ms
Marking	CE
Threaded length	1.65 ln (42 mm)
Height	0.47 ln (12 mm)
Length	2.05 ln (52 mm)
Net weight	0.14 Lb(US) (0.065 kg)

Environment

Product certifications	CCC UL CSA Ecolab
Ambient air temperature for operation	-13...158 °F (-25...70 °C)
Ambient air temperature for storage	-40...185 °F (-40...85 °C)
Vibration resistance	25 gn +/- 2 mm 10...55 Hz)IEC 60068-2-6
Shock resistance	50 gn 11 ms IEC 60068-2-27

Ordering and shipping details

Category	22486 - SENSORS, PROXIMITY
Discount Schedule	DS2
GTIN	03389110926750
Nbr. of units in pkg.	1
Package weight(Lbs)	2.40 Oz (68 g)
Returnability	No
Country of origin	FR

Packing Units

Unit Type of Package 1	PCE
Package 1 Height	0.98 ln (2.5 cm)
Package 1 width	5.20 ln (13.2 cm)
Package 1 Length	4.88 ln (12.4 cm)
Unit Type of Package 2	BAG
Number of Units in Package 2	1
Package 2 Weight	2.93 Oz (83 g)
Package 2 Height	0.79 ln (2 cm)
Package 2 width	7.87 ln (20 cm)
Package 2 Length	5.91 ln (15 cm)
Unit Type of Package 3	S02
Number of Units in Package 3	22
Package 3 Weight	3.98 Lb(US) (1.804 kg)
Package 3 Height	5.91 ln (15 cm)
Package 3 width	11.81 ln (30 cm)
Package 3 Length	15.75 ln (40 cm)

Offer Sustainability

Sustainable offer status	Green Premium product
California proposition 65	WARNING: This product can expose you to chemicals including: Diisononyl phthalate (DINP), which is known to the State of California to cause cancer, and Diisodecyl phthalate (DIDP), which is known to the State of California to cause birth defects or other reproductive harm. For more information go to www.P65Warnings.ca.gov
REACH Regulation	REACH Declaration
EU RoHS Directive	Pro-active compliance (Product out of EU RoHS legal scope) EU RoHS Declaration
Mercury free	Yes
RoHS exemption information	Yes
Environmental Disclosure	Product Environmental Profile
Circularity Profile	End Of Life Information

Contractual warranty

Warranty	18 months
----------	-----------

Dimensions

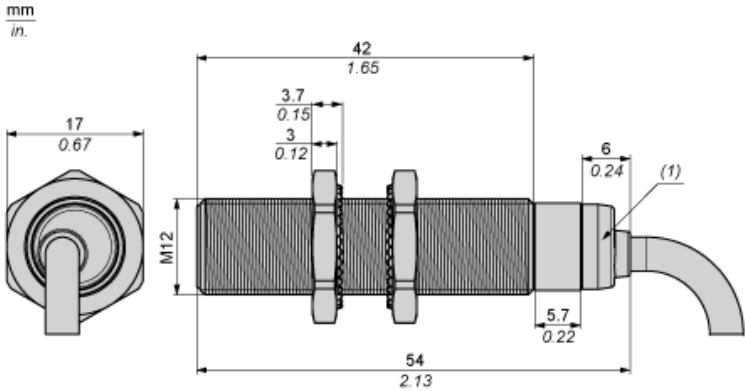

(1) LED

Minimum Mounting Distances

Side by side

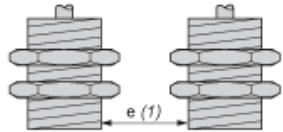

$e (1) \geq 6 \text{ mm}/0.63 \text{ in.}$

Face to face

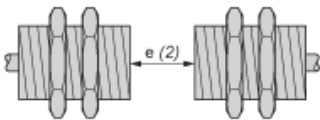

$e (2) \geq 8 \text{ mm}/1.89 \text{ in.}$

Facing a metal object

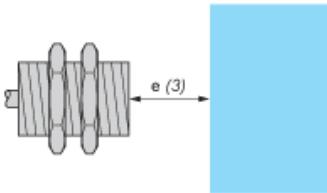

$e (3) \geq 2 \text{ mm}/0.47 \text{ in.}$

Mounted in a metal support

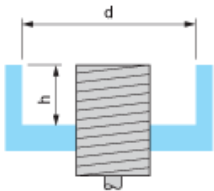

$d \geq 36 \text{ mm}/1.42 \text{ in.}$

$h \geq 8 \text{ mm}/0.31 \text{ in.}$

Mounting

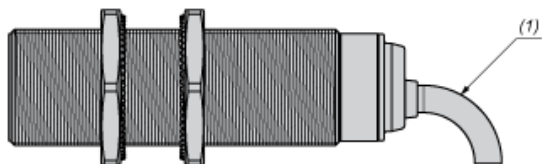

(1) Bending cable: 4 x external cable diameter

Wiring Schemes

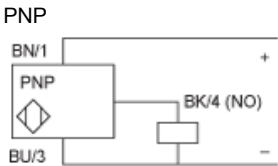

BU : Blue
BN : Brown
BK : Black

Performance Curves

Standard Steel Target : 12x12x1 mm

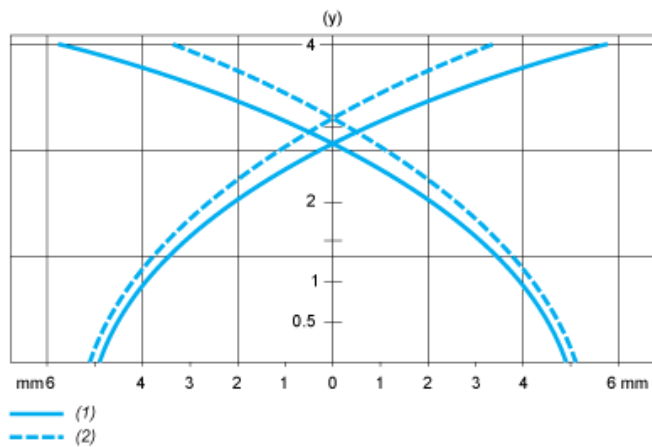

- (1) Pick-up points
- (2) Drop-out points (object approaching from the side)
- (y) Sensing distance in mm

Product Life Status : **Commercialised**